

# F210<sub>F</sub>

QUICK START GUIDE **V1.1**

19th-JAN-2016

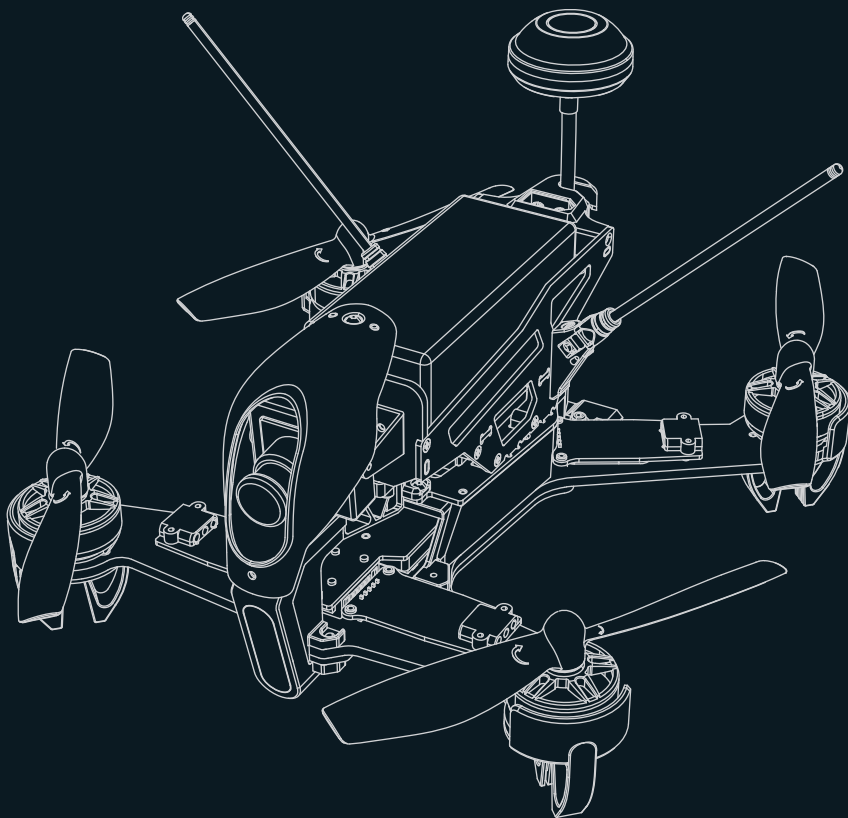

# Contents

1.0 Get to know your aircraft .....	2
2.0 Get to know your Remote Controller .....	3
3.0 Specifications .....	4
4.0 Attention before flight .....	5
5.0 Charge the Battery .....	5
6.0 Prepare the F210 .....	5-6
7.0 Ready for flight .....	7
7.1 Binding of the F210 .....	7
7.2 Motor Unlock / Lock .....	8
8.0 Operation Instruction .....	9-11
9.0 End flight .....	11
10.0 Additional remark .....	12
10.1 DEVO 7 Remote Controller Setting .....	12-13
10.2 OSD information .....	13
10.3 TX5825(FCC)/TX5824(CE) Video transmitting channel selection .....	14
10.4 Introduction for power board .....	14
10.5 Introduction for F210 OSD .....	15
10.6 Introduction for DEVO-RX713 receiver .....	15
10.7 Introduction for FCS-F210(F3) Main Flight Controller .....	16
10.8 Brushless ESC and Brushless Motor connection diagram .....	16
11.0 Instructions for GA009 balance charger .....	17

## 1.0 Get to know your aircraft

- The F210 body is created using CFP for outstanding crash survivability.
- Modern industrial and modular design, improves the product performance and permit easy maintenance and upgrades.
- Advanced 5.8ghz live video and OSD system, for a unforgettable visual FPV experience.
- The F210 employ a modern flight control system for acrobatic flight routines such as roll, flip and race course moves.

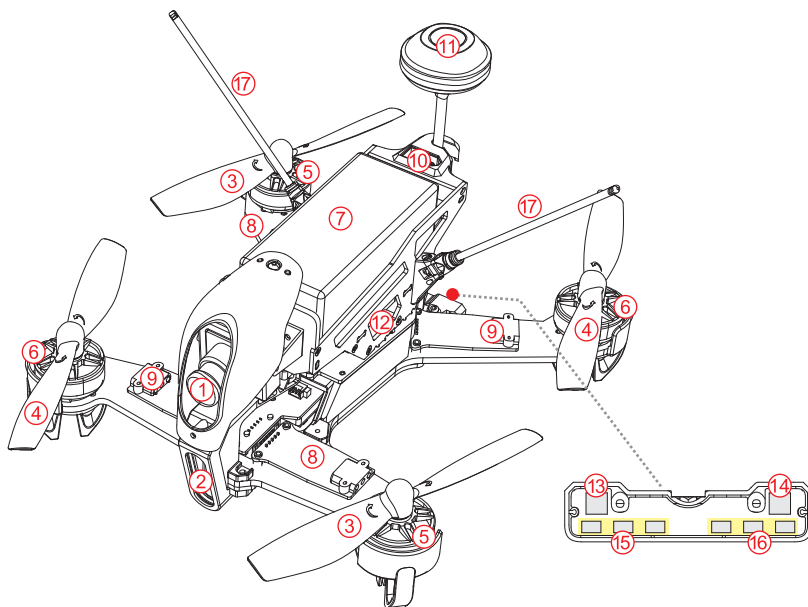

- |  |  |
|--|--|
| 1. Camera  | 9. Brushless ESC(CCW)  |
| 2. Lighting Lamp   | 10. Power port(XT60)   |
| 3. Propeller(CW)   | 11. Mushroom antenna   |
| 4. Propeller(CCW)  | 12. Main Flight Controller   |
| 5. Clockwise motor (levogyrate thread is counterclockwise)   | 13. Left red LED light   |
| 6. Counterclockwise motor (dextrogyrate thread is clockwise) | 14. Right red LED light  |
| 7. Li-Po Battery   | 15. LEFT turn indicator light  |
| 8. Brushless ESC(CW)   | 16. RIGHT turn indicator light   |
|  | 17. DUAL reciever antennas for best performance<br>* always extend before flying |

## 2.0 Get to know your Remote Controller

The F210 feature 3 useful flight modes, STABILIZE / INTERMEDIATE / ADVANCED(RATE) Flight modes are selected by the MIX switch.

\* Select the appropriate mode according to your flight skills.



\* For your first test flight with a new quad, always start with the STABILIZE mode.

※ STABILIZE Flight mode: the main flight controller system comes with stabilization function, its operation is relatively stable, it can not roll, it is suitable for beginners.

※ INTERMEDIATE flight mode: the main flight controller system comes with partial stabilization function, its operation is relatively flexible, it can roll.

※ ADVANCED Flight Mode: the main flight controller system without stabilization function, its operation is very flexible, it can roll.

<b>MODE 2</b> (Throttle stick on the left)	Left stick	THRO/RUDD stick
	Right stick	ELEV/AILE stick
	Left trim	THRO trim
	Right trim	ELEV trim
<b>MODE 1</b> (Throttle stick on the right)	Left stick	ELEV/RUDD stick
	Right stick	THRO/AILE stick
	Left trim	ELEV trim
	Right trim	THRO trim

STABILIZE Flight Mode	INTERMEDIATE Flight Mode	ADVANCED Flight Mode
		
MIX Switch to "0"	MIX Switch to "1"	MIX Switch to "2"

1. HOLD TRN switch
2. GEAR switch
3. AUX2 control
4. Left stick
5. Left trim
6. RUDD trim
7. UP+ key
8. DN- key
9. EXT key
10. FMOD Switch
11. MIX - Flight Mode Switch
12. ELEV/AILE/RUDD D/R Switch
13. Right stick
14. Right trim
15. Power switch
16. AILE trim
17. R+ key
18. L- key
19. ENT key

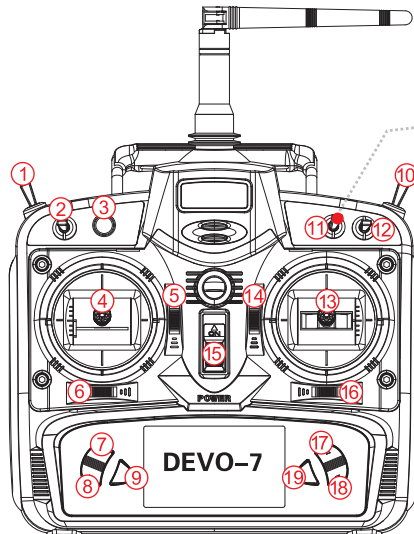

## 3.0 Specifications

### Aircraft

Main Rotor Dia.:	128mm
Overall (L x W x H):	182 x 182 x 103mm
Weight:	370g (Battery excluded)
Remote Controller:	DEVO 7
Receiver:	DEVO-RX713
Main Flight Controller:	FCS-F210(F3)
Transmitter:	TX5825(FCC)/TX5824(CE)
OSD:	F210 OSD
Brushless motor:	WK-WS-28-014A(CW/CCW) KV2500
Brushless ESC:	F210(CW/CCW)
Battery:	14.8V 1300mAh 40C 4S LiPo
Flight Time:	8~9mins
Working Temperature:	-10 C ~ +40 C

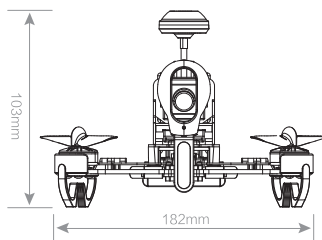
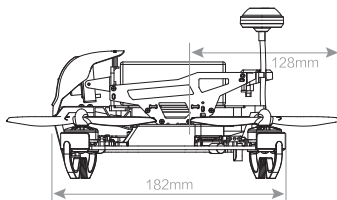

---

### Camera(700TVL)

Horizontal Resolution:	700TVL
System Committee:	PAL/NTSC
Video Out:	1.0Vp-p/75Ω
Power Input:	DC 12V

---

### TX5825(FCC) / TX5824(CE) transmitter

- 5.8G wireless image transmission
- TX5825(FCC) Bind B section: 4 channels
- TX5824(CE) B section: 8 channels
- TX5825(FCC) output power  $\leq 200\text{mW}$
- TX5824(CE) output power  $\leq 25\text{mW}$

## 4.0 Attention before flight

- The F210 mini-quad is recommended for pilots, 14 years or older, with RC hobby experience.
- Only fly the F210 in dry weather, with low wind, please do not fly in rain or heavy foggy conditions.
- Always choose large open fields for flying. Check local LAW and ordinances for legal flying areas.
- Always keep at least 10 feet distance to the aircraft when armed, to avoid injury from high-speed propellers on the ground or while flying. Always disarm before handling the aircraft.
- Do not fly close to high-voltage power lines, cellphone towers, or radio towers, as these may disrupt your control signal.
- ALWAYS check local laws BEFORE flying. NEVER fly over crowds, concerts or sports stadiums.

## 5.0 Charge the Battery

- ① Connect the power-cable to the wall-outlet, the GA009 charger accept voltage from 100v to 240v. When correctly powered the charger LED will be flashing green.
- ② Insert the LiPo battery balance plug into the Ga009 charger.
- ③ During charging the LED will be solid RED. When almost done, the LED will flash RED-GREEN alternately. this indicate the charger is balancing the battery. When charging is completed, the charger will display a solid GREEN LED.

### Attention:

- (1) When the yellow LED light flashes, there may be something wrong with charger or battery, so please stop charging
- (2) Please refer to Page 17 for details of GA009 balance charger.

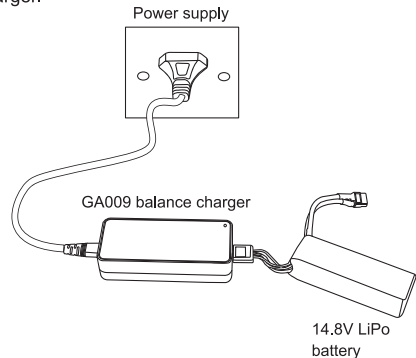

## 6.0 Prepare the F210

### Install mushroom antenna

First, install the mushroom to the mounting brackets as show.

Next, push into the Video Transmitter, Finally tighten the rotating collar with the included wrench.

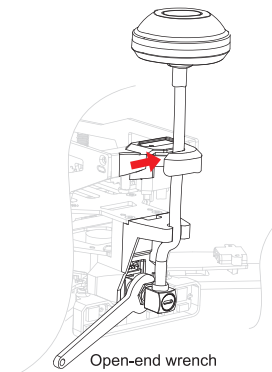

## Install propellers

Fix the clockwise propeller onto the clockwise motor according to the direction of blue arrow, and fix the counterclockwise propeller onto the counterclockwise motor according to the direction of orange arrow. Tighten the propellers manually and make sure the propeller is installed in proper way and fastened.



### Attention:

**Install prop by hand and tighten by holding the motor with the included wrench.**

**You can also use the wrench to help remove broken props in case of a crash.**

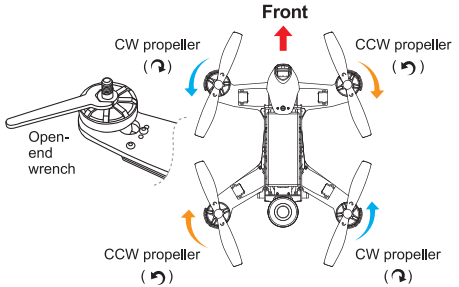

## Battery installation

First put the battery anti-slip mat into the battery compartment.

Put the battery on top and move it forward-backwards as required for perfect balance, then firmly secure the battery with the velcro strap.

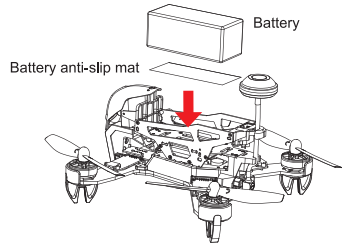

## Gravity center adjustment

Grab the F210 mini-quad by the COG line (center of gravity).

See the illustration for the COG.

Adjust the battery forward-backwards until the quad balances.

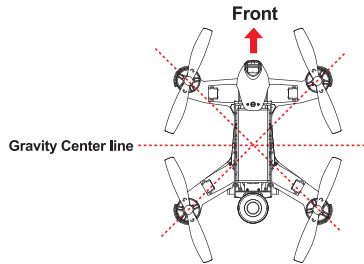

### Attention:

**ALWAYS** unfold the two receiver antennas to their correct STRAIGHT UP position before flying. Do not fly without properly unfolding the antennas.

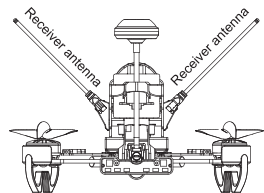

## 7.0 Ready for flight

**⚠ Attention:**

- (1) Place the aircraft in a wide open space, with the rear facing you.  
(This position is known as “TAIL IN”)
- (2) Put all the function switches to the 0 position, put all trims and dials to the Middle position, move the throttle to the lowest position, then turn on the Remote Controller.
- (3) A video receiving equipment is needed( such as DEVO F7, Goggles glasses, etc. ) to display an image and OSD information. ( Setting method please refer to P13 to P15 )
- (4) The F210 mini-quad have a low-voltage alarm beeper.  
And the OSD give you a visual reference for the remaining battery power.  
When voltage reach below 14.0 volts the RIGHT LED light will flash quickly and the beeper will sound alarm.  
The F210 mini-quad is designed for FPV racing, there is no “automatic landing mode”.  
**WARNING: Do not hesitate to land when you hear the alarm or see the OSD indicating 14.0 volts.**

## 7.1 Binding of the F210

- ① Turn on the Remote Controller. (Make sure all the function switches, all trims/knobs and throttle stick at the lowest position)
- ② Put the aircraft on a horizontal place and connect the aircraft power, then the LEFT red LED light turn on. (make sure the positive and negative connected correctly )
- ③ When the RIGHT red LED flashes slowly and turns off , that means the aircraft binds successfully. ( Note: Do not move the F210 during binding )

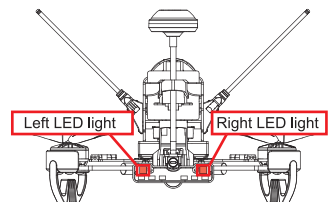
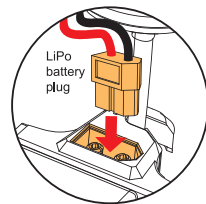
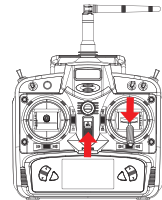



## 7.2 Motor Unlock / Lock

### Motor Unlock

After binding the DEVO 7 to the F210. Check that all trims are neutral, the throttle stick is ALL the way Down with the display indicating 0% throttle. Check that ALL switches are in the UP position.

Gently push the throttle stick down and move the rudder (YAW) stick to the left side and hold for more than 2 seconds. (on mode 2 radios throttle and rudder is the same stick).

You will see the RIGHT red LED light keeps on and buzzer issues a "B B" sound, indicating that motors are unlocked.

Be very careful at this point, as pushing the throttle up will start the motors.

You can test by pushing the stick up a little, the motors should start.

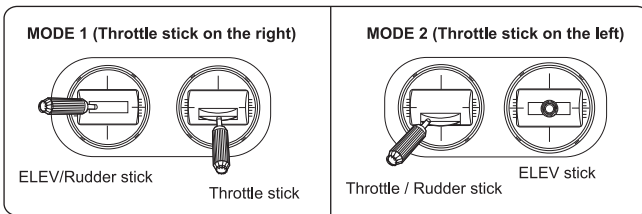

### Motor Lock

Lock the motors by moving the throttle stick all the way down and the rudder (YAW) stick all the way to the right.



The RIGHT red LED light turns off and buzzer issues a "B B" sound when the motors are disarmed.

**TEST:** Push the throttle stick up a little, the motors will not start when locked.

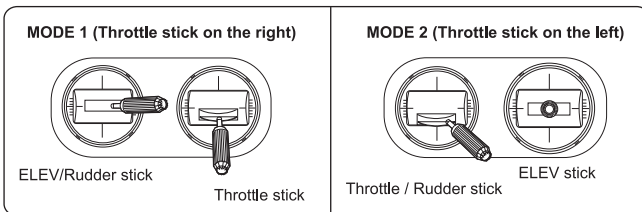
**NOTICE:** The motors are LOCKED by default after successful binding.

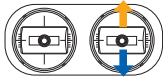
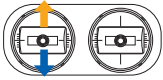
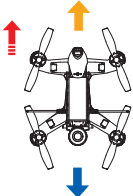
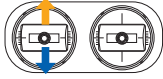

## 8.0 Operation Instruction

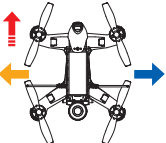
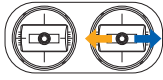
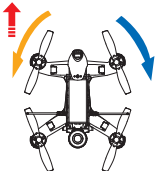
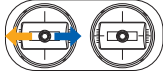
Aircraft posture( ← the direction of head)	Remote Controller control instruction	
<p><b>THROTTLE</b></p> <p>Up/down</p> <p>The rear toward operator</p> 	 <p>MODE 1 (Throttle stick on the right)</p>	 <p>MODE 2 (Throttle stick on the left)</p>
<p><b>PITCH</b></p> <p>Forward/backward</p> <p>When backward, the left/ right turn indicator lights will be solid.</p> 	 <p>MODE 1 (Throttle stick on the right)</p>	 <p>MODE 2 (Throttle stick on the left)</p>
<p><b>ROLL (lean)</b></p> <p>Left / right</p> <p>When lean left, the left turn indicator light will be solid.</p> <p>When lean right, the right turn indicator light will be solid.</p> 	 <p>MODE 1 / MODE 2</p>	
<p><b>YAW (turn)</b></p> <p>Left / right</p> <p>When turn left, the left turn indicator light will flash.</p> <p>When turn right, the right turn indicator light will flash.</p> 	 <p>MODE 1 / MODE 2</p>	

## The aircraft roll forward

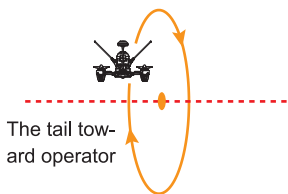

## The aircraft roll backward

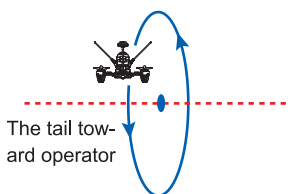

## The aircraft roll left

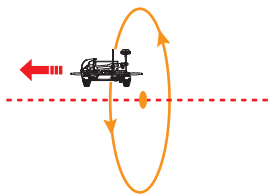

## The aircraft roll right

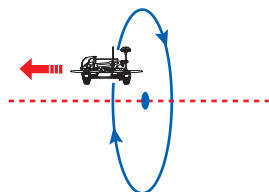

## FLIP & ROLL'S

Are only available in the intermediate & Advanced flight mode. Set MIX switch to position 1 or 2, to select the appropriate flight mode.

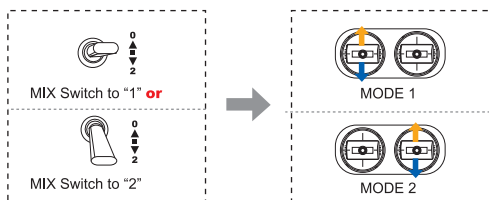

### Attention:

- (1) Always select large open spaces with soft ground for flying.
- (2) Rolls and flips are best suited for experienced pilots.
- (3) Match throttle power to the flight to manage altitude.

## FLIP & ROLL'S

Are only available in the intermediate & Advanced flight mode. Set MIX switch to position 1 or 2, to select the appropriate flight mode.

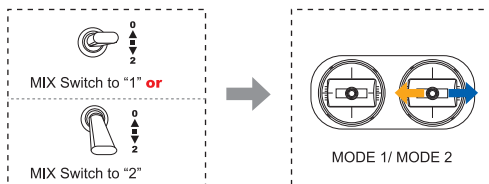

### Attention:

- (1) Always select large open spaces with soft ground for flying.
- (2) Rolls and flips are best suited for experienced pilots.
- (3) Match throttle power to the flight to manage altitude.

## DERAM Baron AKA Proximity FPV obstacle flying

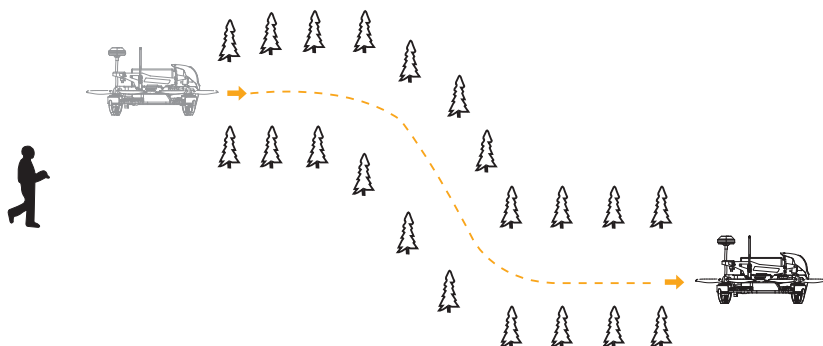

### Attention:

- (1) Dream Baron is more suitable for experienced pilots, highspeed obstacle avoidance flights require advanced skills.
  - (2) Recommended FPV range 300m depending on environment.
  - (3) Avoid flying over people, animals, do not fly over crowds, concerts or sports stadiums. Avoid flying close to powerlines and cellphone towers as these may crash you. Visit [walkera.com](http://walkera.com) for more suggestions and for WALKERA racing gates.
- 

## 9.0 End flight

- ① Land the aircraft, disarm(lock) the aircraft.
- ② First Power off the aircraft by unplugging the battery, then turn off the radio.
- ③ Finally, remove the battery from the aircraft.

## 10.0 Additional remark

### 10.2 DEVO 7 Remote Controller Setting

#### ● Boot Screen(Main interface)

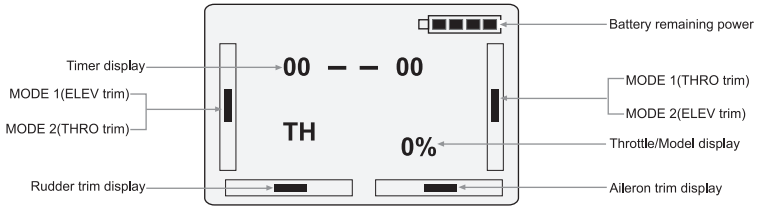

#### ● SELEC

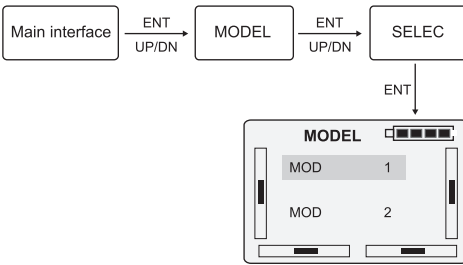

Press UP or DN to select "MOD 1", press ENT to confirm and then press EXT to return to MODEL.

#### ● NAME

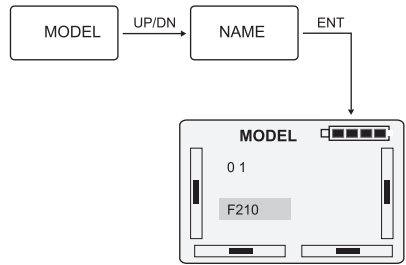

Press R or L button to change the character and figure, named model as F210. Press ENT to confirm and then press EXT to return to MODEL.

#### ● TYPE

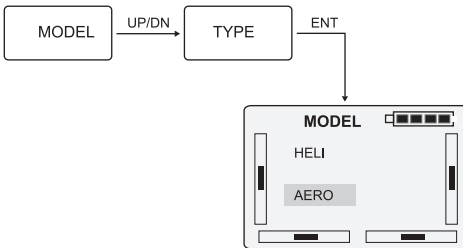

Press UP or DN to select AERO, Press ENT to confirm and then press EXT to return to MODEL.

#### ● WING

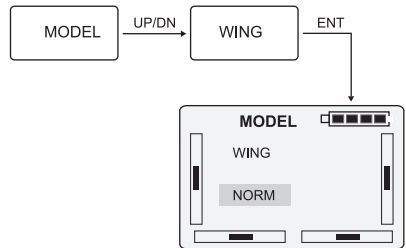

Press R or L to select NORM, Press ENT to confirm and then press EXT to return to MODEL.

● OUTPUT

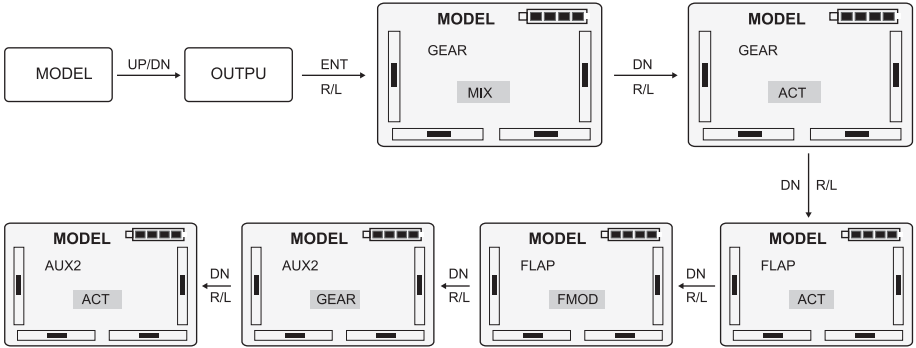

After setup, press ENT to confirm and then press EXT to return to Main interface.

● REVSW

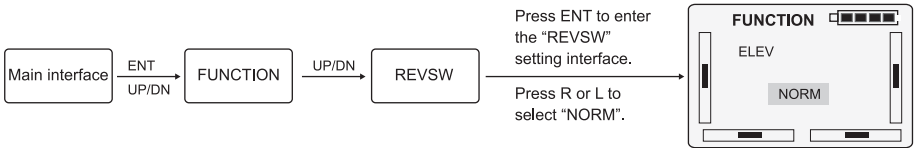

ELEV	AILE	THRO	RUDD	GEAR	FLAP	AUX2
NORM	NORM	NORM	NORM	NORM	NORM	NORM

After settings, press ENT to confirm and then press EXT to return to Main interface.

10.2 OSD information

The OSD information is visible on your video reciever.

\* Goggles, Devo F7 or screen with video reciever.

The video switch and OSD(C) module code switch, please refer to page 14, 15.

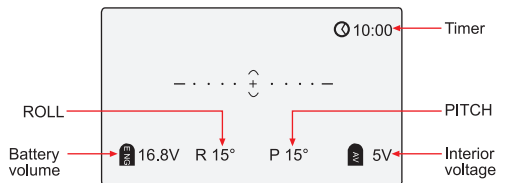

### 10.3 TX5825(FCC)/TX5824(CE) Video transmitting channel selection

There are 8 channels available, chose the best channel based on the image quality on your screen. Select the channel by adjusting the dip-switches on the video-transmitter according to the diagram.

Channel	1	2	3	4	5	6	7	8
Frequency	5866MHz	5847MHz	5828MHz	5809MHz	5790MHz	5771MHz	5752MHz	5733MHz
Code position (on/off)								



**Attention:**

- (1) Only 2, 4, 6, 8 channels are available for the TX5825(FCC) transmitter.
- (2) Video transmitter channel must match the reciever channel.

### 10.4 Introduction for power board

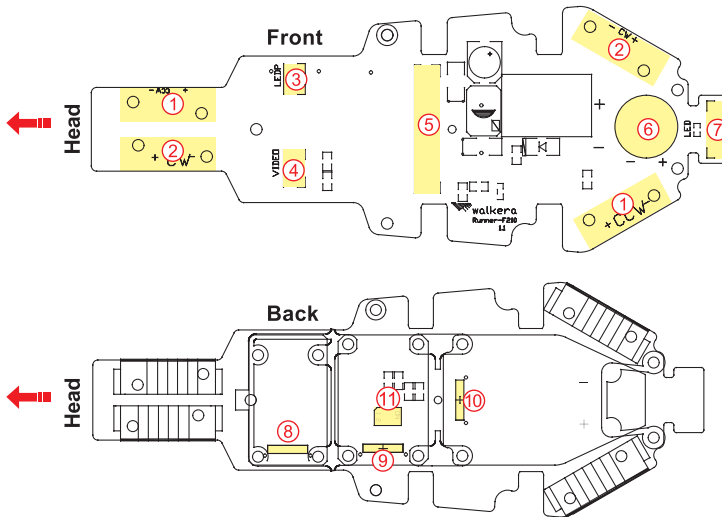

- 1. Brushless ECS connect position(CCW)
- 2. Brushless ECS connect position(CW)
- 3. Lighting Lamp connect port
- 4. Camera connect Port: (3 pins/11.1V)
- 5. Main controller Flexible flat cable connect port
- 6. Buzzer: a kind of alarm device which will alarm automatically when the signal between the aircraft and remote controller lost suddenly or battery voltage lower than 14.0V.
- 7. Rear LED light connect port
- 8. Receiver connect Port
- 9. OSD connect port
- 10. Transmitter connect port
- 11. Video switch: Without OSD, Please turn the switch from "1" to "ON" position to start the video.  
With OSD, Please turn the switch to "1" position to shut off the video.

## 10.5 Introduction for F210 OSD

### Upgrade

Please go to the official Walkera website for update details, use the UP02 cable and connector.

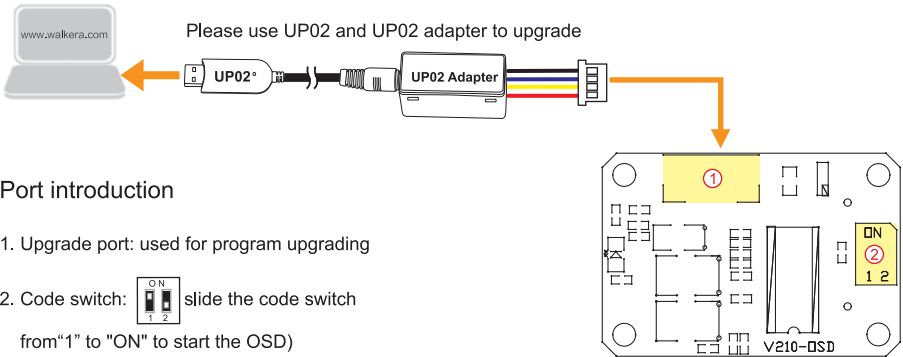

## 10.6 Introduction for DEVO-RX713 receiver

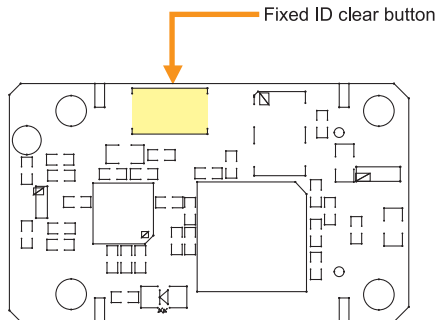

### Fixed ID Code - clearing method

If you want to clear the fixed-ID, after having set a fixed-ID from the remote controller, Press the CLEAN button and power the F210, when successful, the receivers RED LED will blink slowly to indicate the fixed-ID have been cleaned. Make sure you set the Remote Controllers fixed-ID setting to OFF. (to set a fixed-ID, please refer to the remote controller manual)



## 10.7 Introduction for FCS-F210(F3) Main Flight Controller

### Flexible flat cable connection

The metal surface of flexible flat cable plug should be inserted upward to main controller port properly.



The metal surface of flexible flat cable plug should be inserted downward to power board port properly.

### Port introduction

1. 4 pins port: Not used
2. 6 pins port: Not used
3. USB port: used for upgrading
4. Connection port: used to connect flexible flat cable

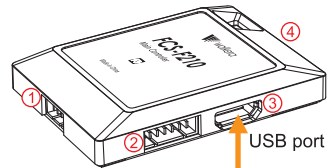

### Upgrading

Please upgrade online via Walkera official website

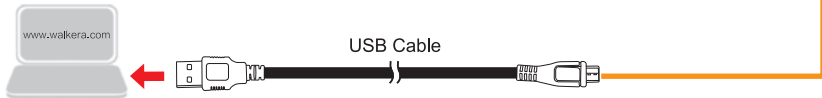

## 10.8 Brushless ESC and Brushless Motor connection diagram

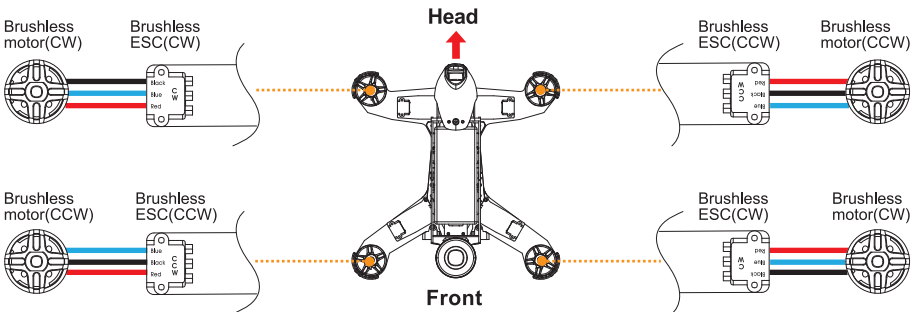

## 11.0 Instructions for GA009 balance charger

General specifications of the GA009 automatic balance charger

Input voltage	Output current	Output Power	Dimension
100-240V 50/60HZ	3.3A	60W	137 x 57 x 32mm

### Instructions for the GA009 balance charger

- (1) GA009 utilizes microcomputer chips to monitor and control over the whole charging process in a balanced way with LED indicator to display the charging status at real time.
- (2) GA009 can be used to charge 3S & 4S (11.1V & 14.8V) Li-ion and Li-Polymer battery packs.

### 3S battery to GA009 charger connection diagram

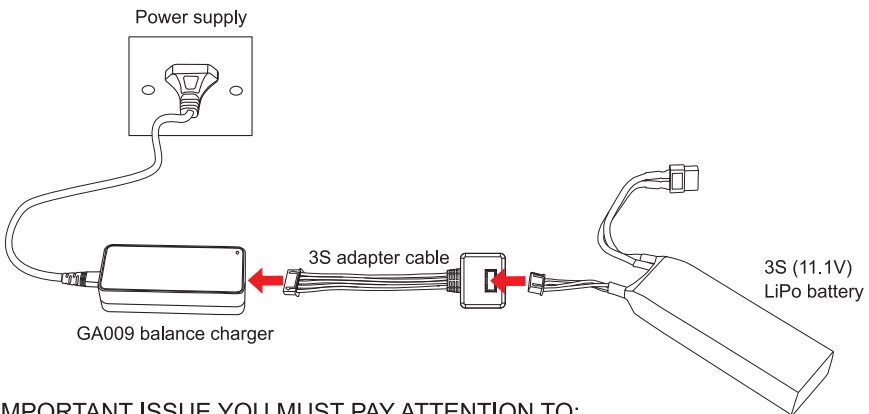

### IMPORTANT ISSUE YOU MUST PAY ATTENTION TO:

- (1) The GA009 can ONLY be used for charging 3S and 4S batteries.  
NEVER EVER attempt to charge more than ONE battery at any time, the charger may get damaged or catch fire.
- (2) During charging, the GA009 should be placed in a dry and ventilated place, far away from heat sources and far away from flammable or explosive substances.
- (3) ALWAYS remove the battery from the aircraft before charging.  
Never charge unsupervised, stay close and keep an eye on the charger for the entire duration of the process.
- (4) Always allow the battery to cool down before charging, at least 10 minutes.  
Overheated batteries may swell or catch fire while charging.
- (5) Before connecting the battery, make sure the correctness of polarity.
- (6) Avoid dropping a charging battery.
- (7) DO NOT charge a damaged battery, if the battery have cuts, swelling or bend, do NOT charge.
- (8) Dispose of damaged batteries by submerging in a pot of salt-water for 30 minutes, then give to battery recycling place.



 Tel: 400-9318-878

User manual is subject to change without prior notice.

Please go to Walkera official website to get the latest version.

