

# ***RUNNER* 250**

QUICK START GUIDE **V1.2**

17th-Sep-2015 Revised

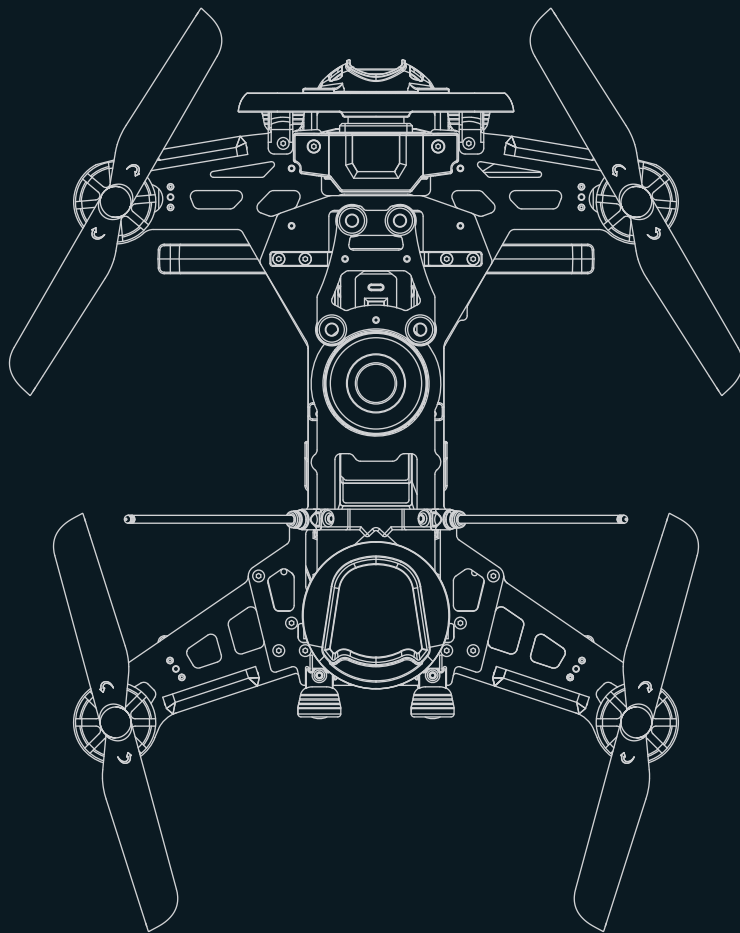

# Contents

<b>1.0 Get to know your aircraft</b> .....	2
<b>2.0 Get to know your Remote Controller</b> .....	3
<b>3.0 Specifications</b> .....	4
<b>4.0 Attention before flight</b> .....	5
<b>5.0 Charge the Battery</b> .....	5
<b>6.0 Assemble</b> .....	5-7
<b>7.0 Ready for flight</b> .....	8
7.1 Binding of the Runner 250 .....	8
7.2 Compass Calibration .....	9
7.3 Gyro Calibration .....	9
7.4 Accelerometer Calibration .....	10
7.5 GPS indicator lights .....	10
7.6 Motor Unlock / Lock .....	10
<b>8.0 Operation Instruction</b> .....	11-13
<b>9.0 End flight</b> .....	13
<b>10.0 Additional remark</b> .....	14
10.1 DEVO F7 Remote Controller Setting .....	14-15
10.2 DEVO 7 Remote Controller Setting .....	16-17
10.3 TX5816(FCC)/TX5817(CE) emitter transmitting channel selection .....	17
10.4 Introduction for power plate .....	18
10.5 Introduction for RUNNER 250 OSD(R) .....	18
10.6 Introduction for FCS-RUNNER 250(R) Main Controller .....	19
10.7 Introduction for DEVO-RX710(R) receiver .....	19
10.8 Blushless ESC and Blushless Motor connection diagram .....	20
<b>11.0 Camera(1920x1080P) Instructions</b> .....	20-21
<b>12.0 Instructions for GA005 balance charger</b> .....	22

## 1.0 Get to know your aircraft

- Adopting the CFP material for the main body, the racer possesses superior toughness and strong anti-impact ability.
- The brand new industrial and modular design, greatly improve the product extension, which enable it much easier to maintain and upgrade.
- The 5.8G real-time image transmission system and OSD system, can bring you the unforgettable visual enjoyment.
- Equip with dual GPS module, the runner 250 advance can realize GPS hold mode, and one key return to home.
- The racer can do acrobatic flights such as roll up-to-down, left-to-right, dream baron. Which gives the user unparalleled flight enjoyment.

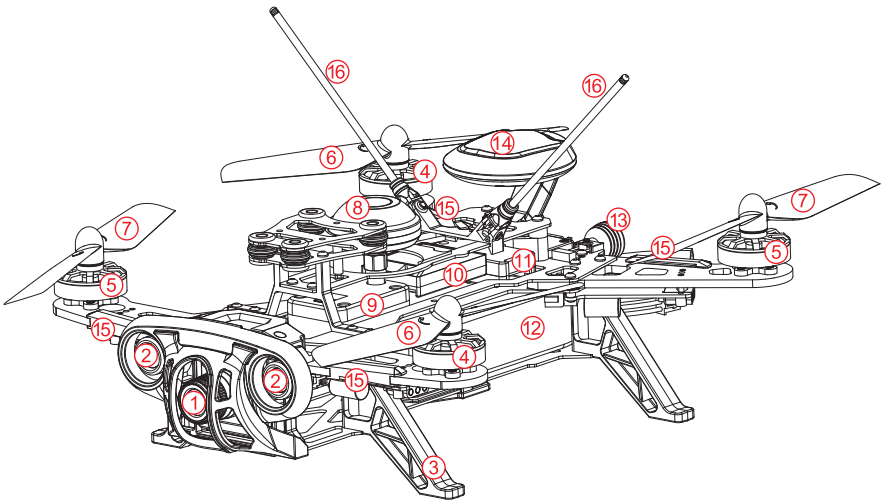



- |  |   |
|--|---|
| 1. Camera  | 8. Mushroom antenna                     |
| 2. White LED light x2  | 9. TX5816(FCC)/TX5817(CE) emitter       |
| 3. Landing gear x4   | 10. FCS-RUNNER 250(R) Main Controller   |
| 4. Clockwise motor (levogyrate thread is counterclockwise)   | 11. DEVO-RX710(R) Receiver              |
| 5. Counterclockwise motor (dextrogyrate thread is clockwise) | 12. Battery: 11.1V 2200mAh 25C 3S Li-Po |
| 6. Clockwise propeller                                       | 13. Red LED light x2                    |
| 7. Counterclockwise propeller                                | 14. GPS                                 |
|  | 15. Direction indicator light x4        |
|  | 16. Receiver antenna                    |

## 2.0 Get to know your Remote Controller

DEVO-F7 in-built with the 5.8G Image transmission system, easy to receive the aerial photos. Equip with the GPS hold mode/one key return to home, Normal mode/roll mode, camera control etc function switch, the runner 250 is easier to control.

<b>MODE 2</b> (Throttle stick on the left)	Left stick	THRO/RUDD stick
	Right stick	ELEV/AILE stick
	Left trim	THRO trim
	Right trim	ELEV trim
<b>MODE 1</b> (Throttle stick on the right)	Left stick	ELEV/RUDD stick
	Right stick	THRO/AILE stick
	Left trim	ELEV trim
	Right trim	THRO trim

(0) GPS-hold Mode	(1) Manual Mode	(2) Return TO Home
		
<b>MIX Switch to "0"</b>	<b>MIX Switch to "1"</b>	<b>MIX Switch to "2"</b>

1. HOLD TRN switch
2. GEAR switch - Camera start/Stop
3. AUX2 control
4. Left stick
5. Left trim
6. RUDD trim
7. UP+ key
8. DN- key
9. EXT key

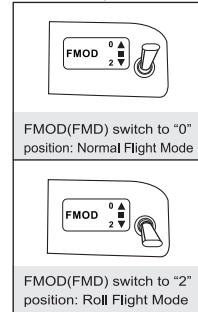
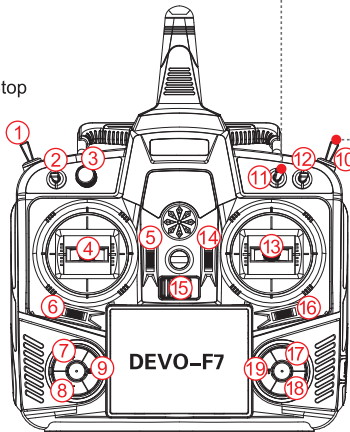

10. FMOD - Flight Mode Switch
11. MIX - Control Mode Switch
12. ELEV/AILE/RUDD D/R Switch
13. Right stick
14. Right trim
15. Power switch
16. AILE trim
17. R+ key
18. L- key
19. ENT key

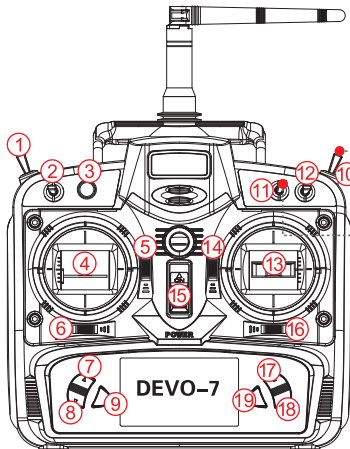

## 3.0 Specifications

### Aircraft

Main Rotor Dia.:	143mm
Overall (L x W x H):	236 x 205 x 102mm
Weight:	446g (Battery excluded)
Remote Controller:	DEVO F7/DEVO 7
Receiver:	DEVO-RX710(R)
Main Controller:	FCS-RUNNER 250(R)
Emitter:	TX5816(FCC)/TX5817(CE)
OSD:	Runner 250 OSD(R)
Brushless Motor:	WK-WS-28-014(CW/CCW)
Brushless ESC:	RUNNER 250
Battery:	11.1V 2200mAh 25C 3S LiPo
Flight Time:	11~12mins
Working Temperature:	-10 C ~ +40 C

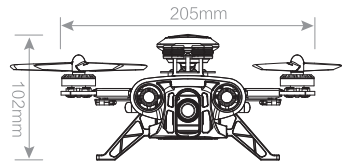
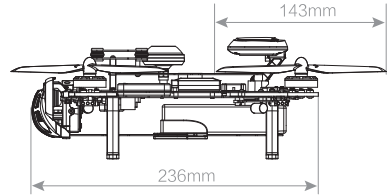

---

### Camera(1920x1080P)

Video Resolution:	1920x1080P 60FPS
Micro SD card:	Max 64G
Video Format:	MOV
Photo:	4000x3000 Pixels
Photo Format:	JPG
Power Input:	DC 5V

### Camera(800TVL)

Horizontal Resolution:	800TVL
System Committee:	PAL/NTSC
Video Out:	1.0Vp-p/75Ω
Power Input:	DC 12V

---

### TX5816(FCC) / TX5817(CE) Emitter

5.8G wireless image transmission

TX5816(FCC) Bind B section: 4 channels

TX5817(CE) B section: 8 channels

TX5816(FCC) output power ≤200mW

TX5817(CE) output power ≤25mW

## 4.0 Attention before flight

- This product is suitable for people who has flight experience of hobby model and ages 14+.
  - Please do not fly the runner 250 advance in the situation that the windpower is more than level 3, either in rainy, sowny or foggy etc bad weather.
  - Please choose the open, legal field to fly, and consider your flight skills and mental status.
  - Please keep a certain distance with aircraft and away from the highspeed rotating parts (such as propellers, brushless motor) during flying.
  - Do not fly it in where there is high-voltage lines, communication base stations or radio towers, in order to avoid signal interference.
  - Don't fly in no-fly zone according to the local laws and regulations.
- 

## 5.0 Charge the Battery

- ① Insert the power adapter(100~240V 50/60HZ),connect the output end to the GA005 balance charger, the balance charger is red LED at this time.
- ② Insert the balanced pin of LiPo battery into GA005.
- ③ During charging, Red LED is continuously flashing. If saturated, Red LED becomes solid green lighting.



**Attention:**  
Please refer to Page 22 for details of  
GA005 balance charger.

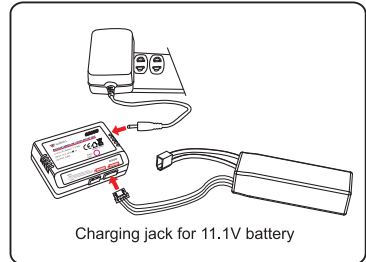

## 6.0 Assemble

### Install GPS compinent

- ① Insert the GPS wires to the GPS port of the FCS-RUNNER 250(R) Main controller(GPS wires should accross the bottom of the main board first)and sort them well.

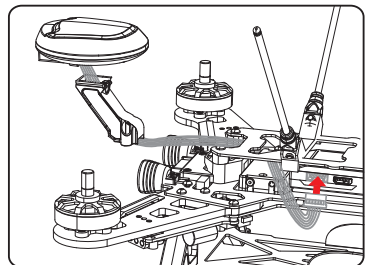

- ② Fix the GPS support frame to the fixed block with screw(PB2x6).

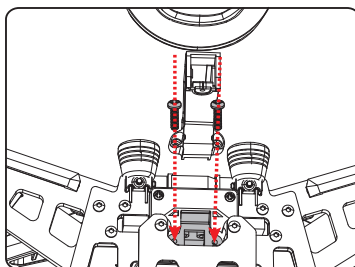

- ③ Slipping GPS shell into its frame.

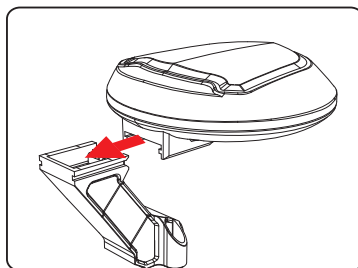

- ④ Fix with screw(KB1.7x6).

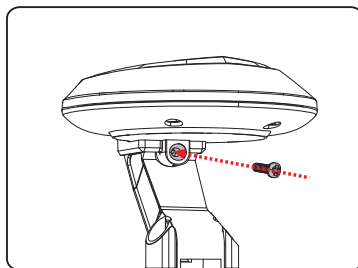

## Install propellers

Fix the clockwise propeller onto the clockwise motor according to the direction of blue arrow, and fix the counterclockwise propeller onto the counterclockwise motor according to the direction of orange arrow. Tighten the propellers manually and make sure the propeller is installed in proper way and fastened.

**Attention:**  
To convenient install or take off the propellers, please use the open-end wrench to stuck the motor side hood (shown at right).

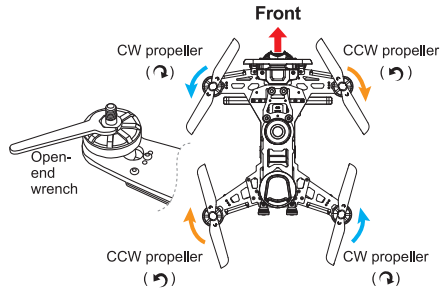

## Battery installation

Put the battery and the Battery anti-slip mat into the Runner 250, balance the gravity, keep the head and the tail parts aligned, then fasten the battery with the Velcro strap.

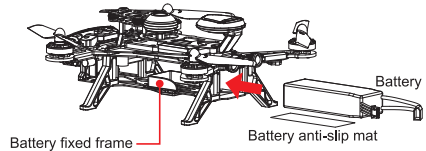

## Gravity center adjustment:

Hold the gravity center line for the fulcrum to balance it. If the head inclines to drop, indicates the gravity center in the head part, require to move the battery backward;

On the contrary, If the tail inclines to drop, indicates the gravity center in the tail part, require to move the battery forward.

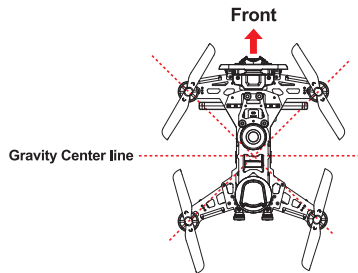

**Attention:**  
The receiver antenna has to be straightened before the flight, to lengthen the communication distance.

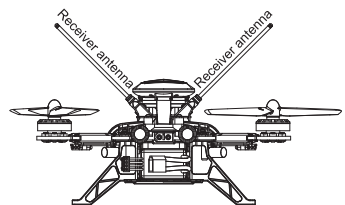



## 7.0 Ready for flight

 **Attention:**

- (1) Place the aircraft on a flat surface, in an open space, with the back facing you.
- (2) Put all the function switches to the 0 position, put all trims/knobs to the Middle position, move the throttle to the lowest position, then turn on the Remote Controller.

## 7.1 Binding of the Runner 250

- ① Turn on the Remote Controller. (Make sure all the function switches, all trims/knobs and throttle stick at the correct position)

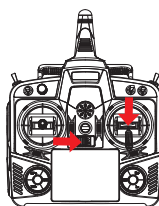

- ② Put the aircraft to the horizontal place and connect the aircraft power. (make sure the positive and negative connected correctly )

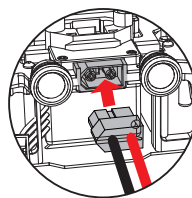

- ③ After 5 sec. the right red LED light will stop flashing indicating that the code binding has finished. (Note: When binding, do not move the runner 250.)

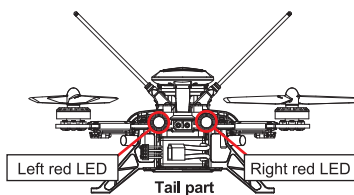

## 7.2 Compass Calibration

**! Attention:**

- (1) When come to a new flying ground or change the flying ground far away from original place, please calibrate compass first.(the motor must be locked and right red LED go out )
- (2) When binding, please choose the open field that is away from the strong electromagnetic.

The compass calibration steps are as follow:

- ① Enter the calibration mode. Do this by moving both sticks DOWN and to the middle position at the same time. The aircraft will start a blinking fast RED.
- ② Forward rotation. Smoothly rotate the aircraft forward in 90 degree increments, pausing for 1 second every 90 deg. (0 / 90 / 180 / 270 / 360)
- ③ Clockwise rotation. Rotate the aircraft around the roll axis smoothly in 90 deg increments. Pausing 1 second for each 90 deg. (0 / 90 / 180 / 270 / 360)
- ④ Horizontal rotation. Rotate the aircraft around the YAW axis smoothly in 90 deg increments. Pausing 1 second for each 90 deg.(0 / 90 / 180 / 270 / 360)
- ⑤ Nose down rotation. Rotate the aircraft facing the nose down. rotate smoothly in 90 deg increments. Pausing 1 second for each 90 deg. (0 / 90 / 180 / 270 / 360)
- ⑥ Place the aircraft in normal position. The rapid RED blinking will stop. This indicates that the calibration is finished. Disconnect the battery to save the settings.

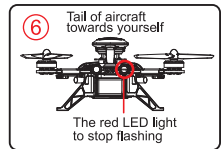
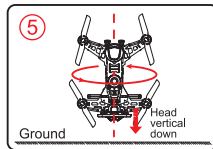
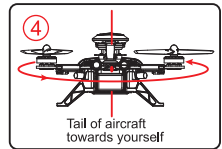
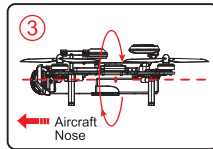
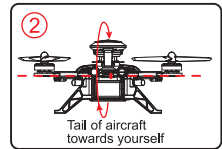
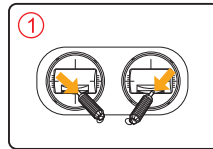

## 7.3 Gyro Calibration

The flight control system can do the Gyro Calibration automatically when the aircraft makes the code binding. You can also use the following methods to calibrate (The motor must be locked and right red LED go out).

- (1) Put aircraft to the horizontal position and keep static.
- (2) **MODE 1:** Push the throttle stick to the lowest point, and move Elevator/Rudder stick to the bottom right corner, enter into calibration mode.  
**MODE 2:** Push the Throttle/Rudder stick to the lowest point and right side, move the Elevator stick to the bottom, enter into the Calibration Mode.

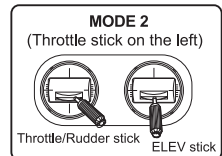
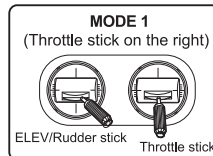

- (3) Right red LED indicator blinks once and lights off, means finished calibration.

## 7.4 Accelerometer Calibration

The flight control system can do the Accelerometer Calibration automatically when the aircraft makes the code binding. You can also use the following methods to calibrate (The motor must be locked and right red LED go out).

(1) Put aircraft to the horizontal position and keep static.

(2) **MODE 1:** Push the throttle stick to the highest point, and move Elevator/Rudder stick to the bottom right corner, enter into calibration mode.

**MODE 2:** Push the Throttle/Rudder stick to the highest point and right side, move the Elevator stick to the bottom, enter into the Calibration Mode.

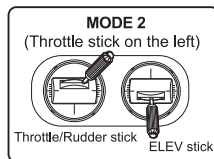
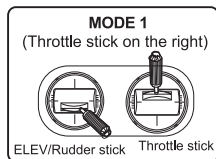

(3) Right red LED indicator blinks once and lights off, means finished calibration.

**Please re-calibrate Gyro and Accelerometer if the aircraft no gyro response or status is not stable.**

## 7.5 GPS indicator lights

GPS Satellites	<6	6	7	8	9	10	11	12	13
The left red LED status	No blinking	Blinking once	Blinking 2 times	Blinking 3 times	Blinking 4 times	Blinking 5 times	Blinking 6 times	Blinking 7 times	Blinking 8 times

**IMPORTANT:** For SAFE flight in GPS flight mode:

The left red LED light should at least "double" blink, (two blinks at a time).

It is highly recommended that you wait for "triple blink" 8 statelites before starting the flight.

**NEVER attempt to AUTO-START with less than "triple blinks"**

## 7.6 Motor Unlock / Lock

### Motor Unlock

After binding the DEVO F7/DEVO 7 to the Runner 250, Check that all trims are neutral, the throttle stick is ALL the way Down with the display indicating 0% throttle. Check that ALL switches are in the UP position. Gently push the throttle stick down and move the rudder (YAW) stick to the left side. (on mode 2 radios throttle and rudder is the same stick). You will see the right red LED light turn on, indicating that motors are unlocked. Be very careful at this point, as pushing the throttle up will start the motors.

You can test by pushing the stick up a little, the motors should start.

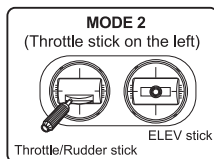
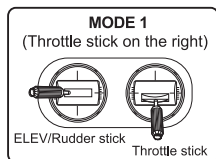

### Motor Lock

Lock the motors by moving the throttle stick all the way down and the rudder (YAW) stick all the way to the right. The right red LED light will go out when the motors are disarmed.

**TEST:** Push the throttle stick up a little, the motors will not start when locked.

**NOTICE:** The motors are LOCKED by default after successful binding.

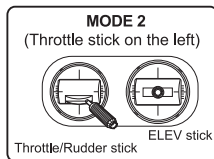
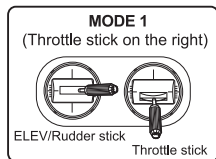

## 8.0 Operation Instruction

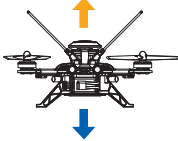
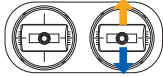
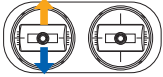
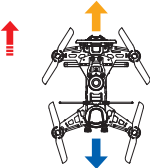
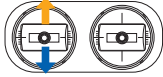
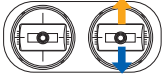
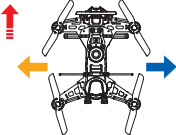
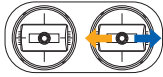
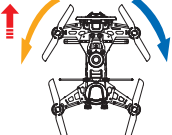
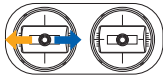
Aircraft posture( ← the direction of head)	Remote Controller control instruction	
<p><b>THROTTLE</b></p> <p>Up/down</p> <p>The tail toward operator</p> 	 <p>MODE 1 (Throttle stick on the right)</p>	 <p>MODE 2 (Throttle stick on the left)</p>
<p><b>PITCH</b></p> <p>Forward/backward</p> <p>When backward, the left/ right direction indicator lights will be solid.</p> 	 <p>MODE 1 (Throttle stick on the right)</p>	 <p>MODE 2 (Throttle stick on the left)</p>
<p><b>ROLL (lean)</b></p> <p>Left / right</p> <p>When lean left, the left direction indicator light will be solid.</p> <p>When lean right, the right direction indicator light will be solid.</p> 	 <p>MODE 1 / MODE 2</p>	
<p><b>YAW (turn)</b></p> <p>Left / right</p> <p>When turn left, the left direction indicator light will flash.</p> <p>When turn right, the right direction indicator light will flash.</p> 	 <p>MODE 1 / MODE 2</p>	

## The aircraft roll forward

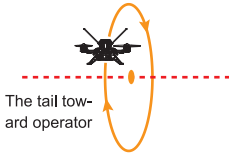

## The aircraft roll backward

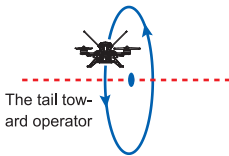

## The aircraft roll left

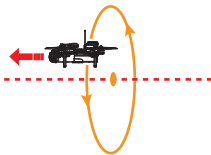

## The aircraft roll right

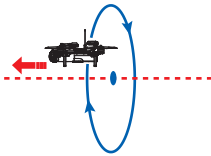

## GPS hold mode

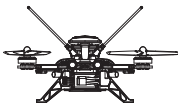

Ground

Ensure the MIX switch on "0" or "1" position, namely GPS hold mode or Manual mode.

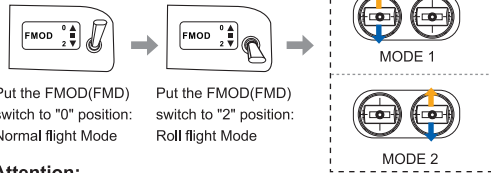

### Attention:

- (1) Please select a larger space, soft ground for flying.
- (2) The rolling mode is more suitable for experienced pilots.
- (3) Need match the throttle for practice during the rolling, when the aircraft drop please up throttle a bit, when the aircraft rise please down the throttle a little.
- (4) When the voltage is low, the aircraft switched automatically from roll mode to normal mode
- (5) In the roll mode, it can not carry out the Return To Home function.

Ensure the MIX switch on "0" or "1" position, namely GPS hold mode or Manual mode.

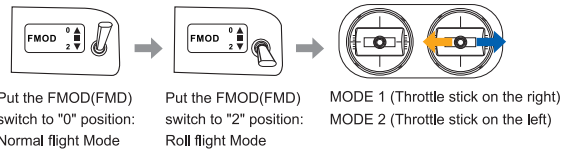

### Attention:

- (1) Please select a larger space, soft ground for flying.
- (2) The rolling mode is more suitable for experienced pilots.
- (3) Need match the throttle for practice during the rolling, when the aircraft drop please up throttle a bit, when the aircraft rise please down the throttle a little.
- (4) When the voltage is low, the aircraft switched automatically from roll mode to normal mode
- (5) In the roll mode, it can not carry out the Return To Home function.

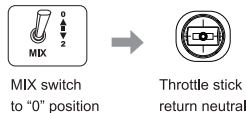

### Attention:

- (1) Enable that you've received GPS signals well (Left red LED light blinks).
- (2) Before switching mode, always put the throttle stick to middle position ( 50% ).
- (3) IF the GPS signal degrades, the Runner 250 will automatically enter "Altitude hold mode" notein this mode it will drift, but will hold its altitude.  
After flying 50% of the battery, do NOT switch from GPS mode to Manual, this may cause a sudden drop / crash.  
You can land in GPS mode, after landing, keep the throttle stick DOWN and switch to manual, then lock the motors.

(4) In the manual mode, the runner 250 advance can not realize the altitude hold function.

## RETURN TO HOME

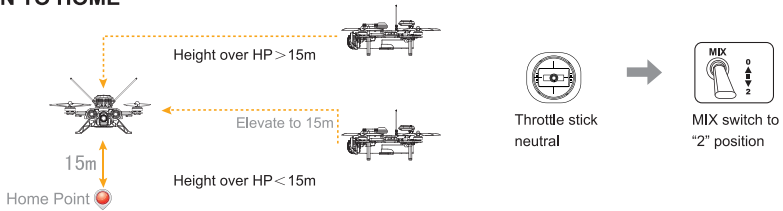

- If the flight altitude is higher than 15m, the aircraft will keep the current altitude and return above the Home Point then descend vertically.
- When the flight altitude is lower than 15m, the aircraft will elevate automatically to 15m then fly back above the Home Point and land vertically.

### Attention:

- Enable that you've received GPS signals well (Left red LED light blinks).
- After engaging Return to Home mode, leave the throttle stick at 50% (centered) DO NOT touch any switches on the Remote Controllers. To REGAIN control of the Runner 250, make sure the throttle is centered, then flip the MIX switch to position "0".  
**In an emergency such as losing the control link between the Remote Controllers and the Runner 250, the Failsafe system will automatically start RTH.**  
 You may not be able to interrupt an emergency RTH, simply let the aircraft continue until it lands.
- When in the process of RETURN TO HOME, if the battery voltage is too low, the aircraft will fall, but can't automatically return, please control the aircraft direction manually, till the aircraft land safely.

## Dream Baron

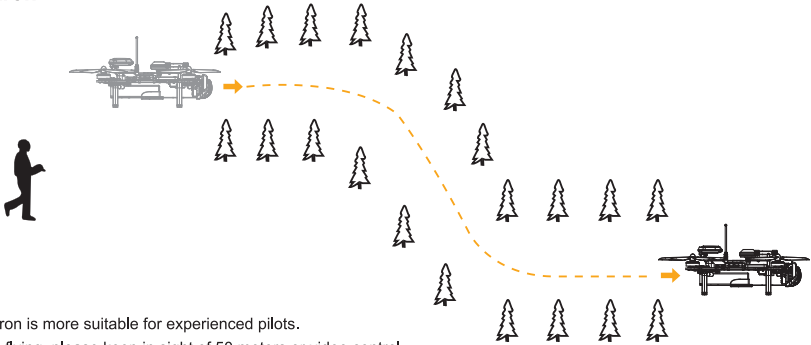

### Attention:

- Dream Baron is more suitable for experienced pilots.
- During the flying, please keep in sight of 50 meters or video control range within 300 meters to control the flight.(Actual range depending on the flight environment and weather conditions.)
- During the flying, please avoid obstacles such as people, animals and power lines.

**When the right-rear red LED light flash slowly, means the battery voltage is too low, the aircraft will fall.**

## 9.0 End flight

- Manual landing or return to home function landing.
- First, power off aircraft battery, then power off Remote Controller battery.
- Take the battery out of aircraft.

## 10.0 Additional remark

### 10.1 DEVO F7 Remote Controller Setting

#### ● Boot Screen(Main interface)

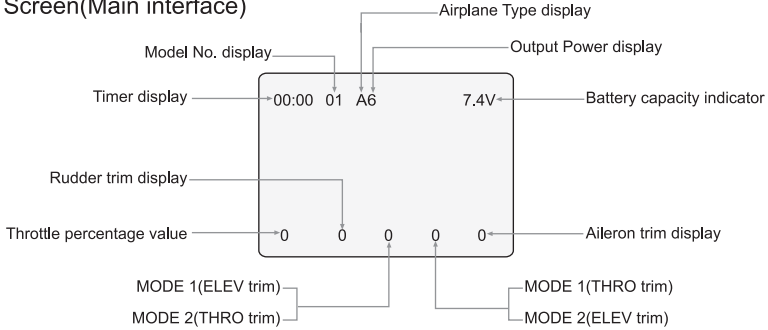

#### ● Model Select

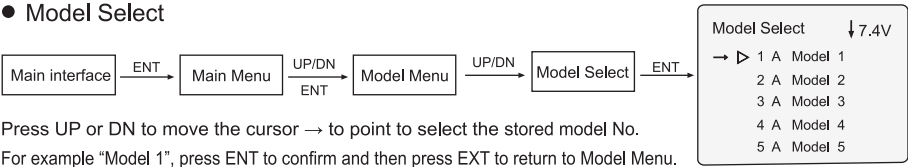

#### ● Model Name

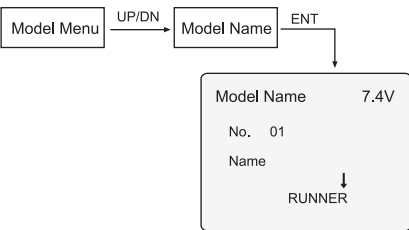

Press UP or DN to move the cursor → to point to select the character and figure which need to be changed, press R or L button to change the character and figure, name model as RUNNER. Press ENT to confirm and then press EXT to return to Model Menu.

#### ● Type Select

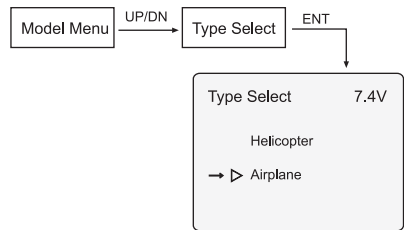

Press UP or DN to move the cursor → to point to Airplane option. Press ENT to confirm and then press EXT to return to Model Menu.

#### ● Wing Type

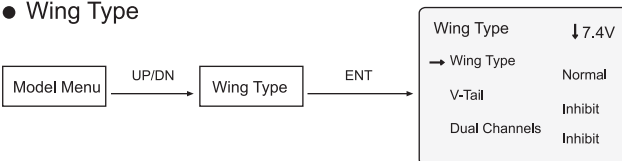

Press UP or DN to move the cursor → to point to Wing Type option, press R or L to select "Normal". Press ENT to confirm and then press EXT to return to Model Menu.

## ● Device Output

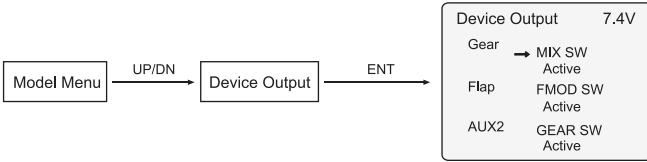

After finish settings, press ENT to confirm and then press EXT to return to Main Menu.

## ● Reverse Switch



Press R or L to select Normal.

After finish settings, press ENT to confirm and then press EXT to return to Main Menu.

Reverse Switch ↓ 7.4V	
→ Elevator	Normal
Aileron	Normal
Throttle	Normal
Rudder	Normal
Gear	Normal

Reverse Switch ↑ 7.4V	
→ Flap	Normal
AUX2	Normal

## ● Video Setting and OSD information

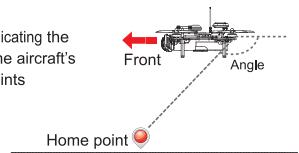
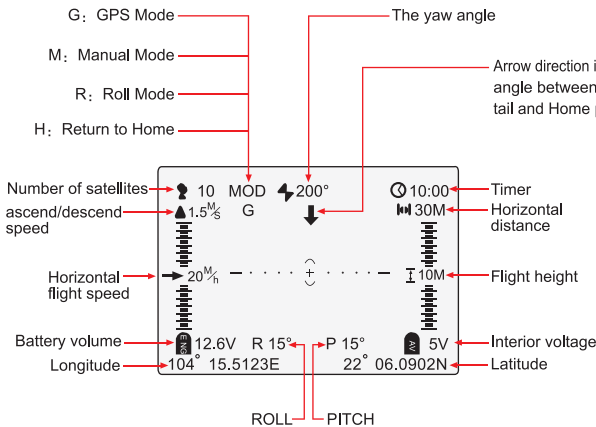
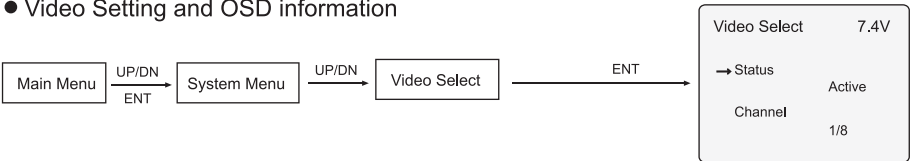

Status: Press R or L to select "Active".  
 Channel: Press R or L to select suitable receiving video channel for the TX5816/TX5817. It will display automatically "OSD" after connection.

After finish settings, press ENT to confirm and then press EXT to return to Main interface.

### ⚠ Attention:

- (1) When the arrow points straight down, pull back the ELEV stick, then the drone will fly back to Home position.
- (2) Slide the video switch and OSD module code switch "1" to "ON", please refer to page 18.



## 10.2 DEVO 7 Remote Controller Setting

### ● Boot Screen(Main interface)

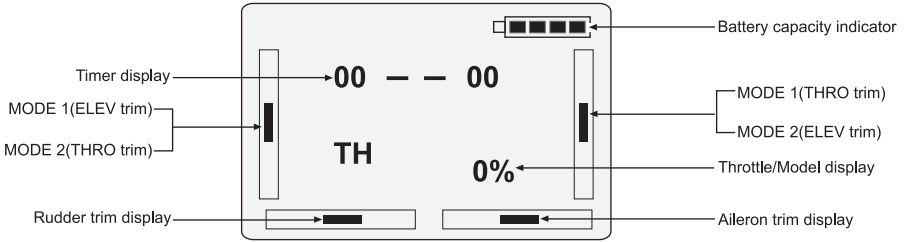

### ● SELEC

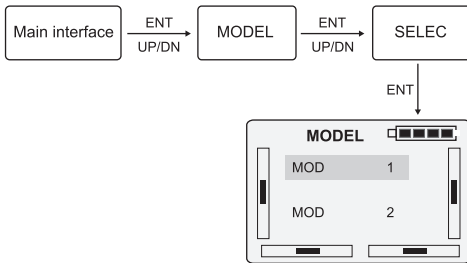

Press UP or DN to select "MOD 1", press ENT to confirm and then press EXT to return to MODEL.

### ● NAME

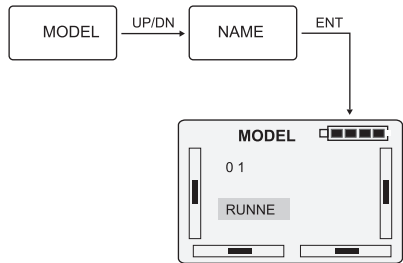

Press R or L button to change the character and figure, named model as RUNNE. Press ENT to confirm and then press EXT to return to MODEL.

### ● TYPE

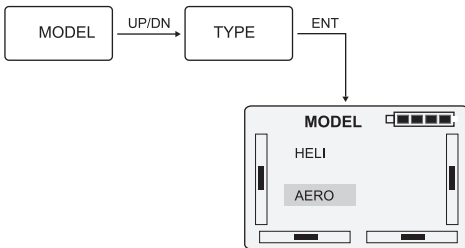

Press UP or DN to select AERO, Press ENT to confirm and then press EXT to return to MODEL.

### ● WING

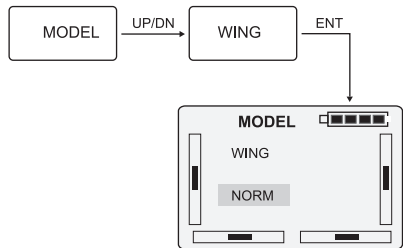

Press R or L to select NORM, Press ENT to confirm and then press EXT to return to MODEL.

● **OUTPUT**

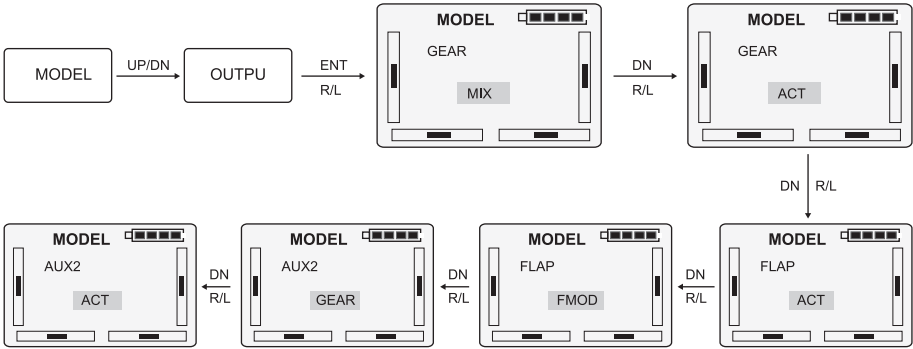

After settings, press ENT to confirm and then press EXT to return to Main interface.

● **REVSW**

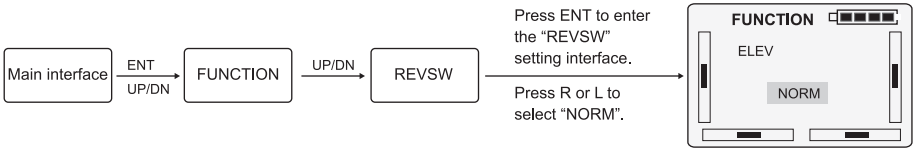

ELEV	AILE	THRO	RUDD	GEAR	FLAP	AUX2
NORM	NORM	NORM	NORM	NORM	NORM	NORM

After settings, press ENT to confirm and then press EXT to return to Main interface.

**Tips: The settings of other remote controller of walkera is same as DEVO F7/7.**

### 10.3 TX5816(FCC)/TX5817(CE) emitter transmitting channel selection

There are 8 different channels can be selected. You can choose the best channel according to the image quality as bellow:

Channel	1	2	3	4	5	6	7	8
Frequency	5866MHz	5847MHz	5828MHz	5809MHz	5790MHz	5771MHz	5752MHz	5733MHz
Code position (on/off)								



**Attention:**

- (1) Only 2, 4, 6, 8 channels are available for the TX5816(FCC) emitter.
- (2) Emitter transmitting channel and remote controller image receiving channel must be correspondent with each other.

## 10.4 Introduction for power board

- 1.Red LED connection port
- 2.DEVO-RX710(R) Receiver install position
- 3.FCS-RUNNER 250(R) Main Controller install position
- 4.TX5816(FCC) or TX5817(CE) emitter install position
5. Video Switch:  Slide the switch to "ON" to start the video
6. Brushless ECS connect position
7. Direction indicator light
8. Camera connect Port: (3 pins/11.1V)
9. Camera connect Port: (5 pins/5V)
10. OSD module install position
11. Receiver input/output channel
12. Buzzer: give an alarm when signal lost.  
Once the drone lost control signal from the remote controller, the alarm funtion will be triggered automatically and keep buzzing to help to find the drone.

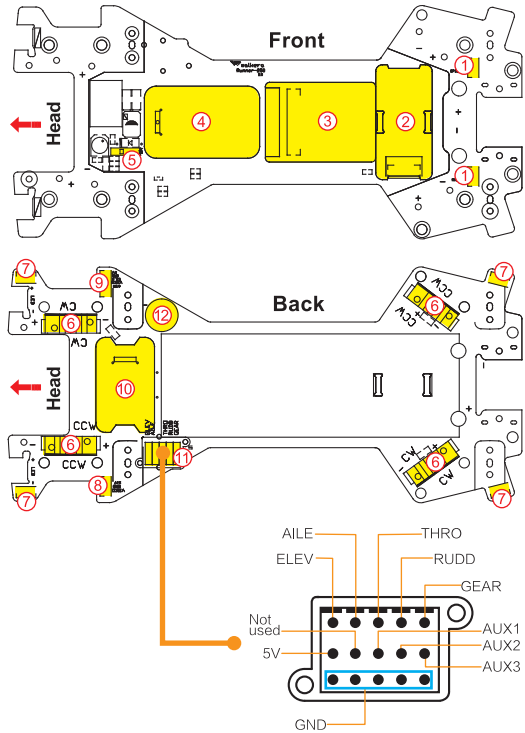

## 10.5 Introduction for RUNNER 250 OSD(R)

### Upgrade

Please go to Walkera official website for online upgrade, cable connection as follows:

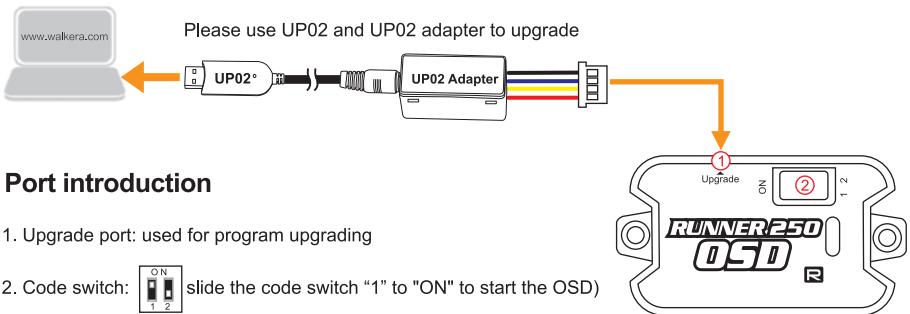

### Port introduction

1. Upgrade port: used for program upgrading
2. Code switch:  slide the code switch "1" to "ON" to start the OSD)

## 10.6 Introduction for FCS-RUNNER 250(R) Main Controller

### Flexible flat cable connection

The metal surface of flexible flat cable plug should be inserted upward to main controller port properly.

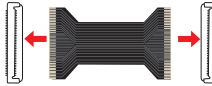

The metal surface of flexible flat cable plug should be inserted downward to power board port properly.

### Port introduction

1. UART port: used for program upgrading
2. GPS Port: connect GPS module
- 3.USB port: used for upgrading and setting parameter
- 4.Connection port: used to connect flexible flat cable

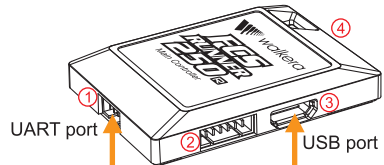

### Upgrade

Please go to Walkera official website for online upgrade, cable connection as follows:

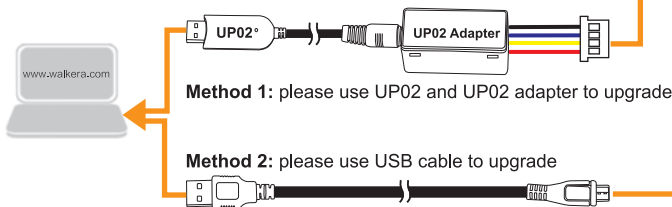

## 10.7 Introduction for DEVO-RX710(R) receiver

### Flexible flat cable connection

The metal surface of flexible flat cable plug should be inserted upward to receiver port properly.



The metal surface of flexible flat cable plug should be inserted downward to power board port properly.

### Port introduction

1. Clean button: Fixed ID clear button
2. Idle port: Not used
- 3.Connection port: used to connect flexible flat cable

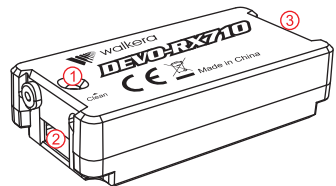

### Fixed ID code cleaning up method

If you want to clear the fixed ID after setting by Remote Controller (Fixed ID setting, details please refer the Remote Controller manual), please press the clean button and power on the aircraft. The receiver fixed ID memory is cleared if the receiver RED LED will flash slowly. Remote Controller fixed ID settings status should be OFF.

## 10.8 Brushless ESC and Brushless Motor connection diagram

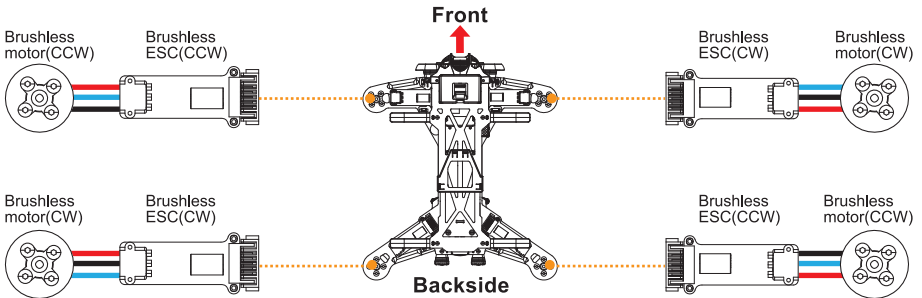

## 11.0 Camera(1920x1080P) Instructions

### 11.1 Pictures illustration

1. Shutter Button
2. Red Indicator
3. Power port(DC 5V)
4. Video/Photo Switch
5. Micro SD card slot

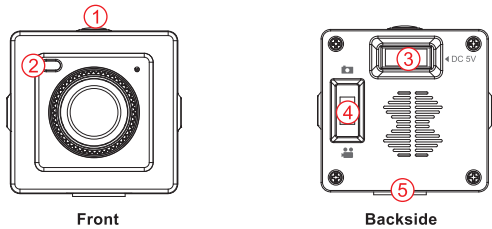

### Warm tips:

- (1) A Micro SD card must be inserted into the camera before power on and removed after power off. (A high speed SD card is recommended.)
- (2) Insert the Micro SD card, after the camera power on, the red indicator will keeps solid.

### 11.2 Video instruction

#### ● Manual Operation

Turn the Video/Photo Switch to , press the shutter button once to start recording (the Red indicator flashes for 0.5sec interval); Press the shutter button again to stop recording (The Red indicator keeps solid).

● Remote Controller Operation

Switch	Remote Controller setting	Instructions
<b>GEAR</b>	<p>Model Menu</p> <p>↓</p> <p>Device Output</p> <p>↓</p> <p>AUX2</p> <p>↓</p> <p>GEAR SW</p> <p>↓</p> <p>Active</p>	<p>① Please turn the video/photo switch to “” position.</p> <p>② <b>Start video:</b> turn the <b>GEAR switch</b> from “0” position to “1” position, wait for 1-2 seconds, then return to the “0” position, the camera will start recording (<b>the red indicator keeps flashing with an interval of 0.5 second</b>).</p> <p><b>Stop recording:</b> turn the <b>GEAR switch</b> from “0” position to “1” position, wait for 1-2 seconds, then return to the “0” position, the camera will stop recording (<b>the red indicator keeps solid red</b>).</p> <p><b>Note:</b> You must stop recording to store the video on the SD card. The video will not be stored if you turn off the power without stopping the recording.</p>

11.3 Photo instruction

● Manual Operation

Turn the video/photo switch to , press the shutter button once, camera will take a photo (the red indicator light out once then keeps solid red), press the shutter button again, it will take another photo.

● Remote Controller Operation

Switch	Remote Controller setting	Instructions
<b>GEAR</b>	<p>Model Menu</p> <p>↓</p> <p>Device Output</p> <p>↓</p> <p>AUX2</p> <p>↓</p> <p>GEAR SW</p> <p>↓</p> <p>Active</p>	<p>① Please turn the video/photo switch to “” position.</p> <p>② Turn the <b>GEAR switch</b> on the Remote Controller from “0” position to “1” position, wait for 1-2 seconds, then return to the “0” position, the camera will start to take a photo (the red indicator light out once then keeps solid red), operate again to take another photo, and so on.</p>

## 12.0 Instructions for GA005 balance charger

### 12.1 Parameters of GA005 balance charger

Input voltage	Input current	Output current	Dimension	Weight
DC15-18V	1000mA	≤800mA	62.5 x 47 x 20.8mm	46g

### 12.2 Features of GA005 balance charger

- (1) GA005 utilizes microcomputer chips to monitor and control over the whole charging process in a balanced way with LED indicator to display the charging status at real time.
- (2) Connects to an input power supply (DC 15-18V 1000 mA).
- (3) GA005 is suitable for 7.4V/ 11.1V Li-ion or Li-polymer battery pack.
- (4) GA005 can detect Li-Po battery automatically. GA005 will automatically charge when it finds the voltage of single cell battery is excessively low. At the same time LED displays as charging status (flash in red). Control single cell battery voltage at the range of  $4.2 \pm 0.05V$  to ensure the maximum voltage difference of single cell in the battery is less than 50 mV.

### 12.3 Instruction of GA005 balance charger

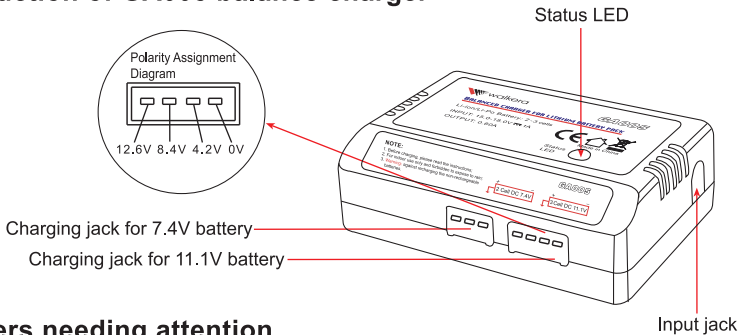

### 12.4 Matters needing attention

- (1) GA005 is only used to charging a 2S or 3S Li-ion or Li-polymer battery. It is forbidden to simultaneously charge two or more sets of batteries. Either the charger or battery may be damaged.
- (2) During charging, GA005 should be put in dry and ventilated place and be far away from heat sources and inflammable and explosive substances.
- (3) When charging, the battery should be removed from your helicopter. Never leave the charger unsupervised during the process of charging in order to avoid risk of accidents.
- (4) Never immediately charge your battery as soon as the flight is finished, or when its temperature doesn't cool down. Otherwise the battery will take a risk in swelling, even a fire.
- (5) Ensure the correctness of polarity before connecting the battery to charger.
- (6) Avoid drop and violence during the process of charging. Drop and violence will result in internal short circuit of the battery.
- (7) For the sake of safety, please use original charging equipment (wall adapter + GA005 balance charger) and battery. Please change new one in time when the old battery pack is becoming swollen due to long time usage.
- (8) If it is retained in the charger for a long time after saturated, the battery may automatically discharge. When the charger detects that the voltage of individual cells is lower than the rated voltage, it will re-charge until saturated. Frequently charging and discharging will shorten the lifetime of your battery.



User manual is subject to change without prior notice.

Please go to Walkera official website to get the latest version.



Walkera official web



Follow us



Follow us